



User Manual B-WL65305 SMD

Before your first use, do please charge and discharge the batteries

Safety precautions

- Do not use the lamp in the immediate vicinity of inflammable materials or gases.
- Make sure that the illuminants are not covered during use.
- Only use the accessories included with the product for recharging your rechargeable workshop lamp.
- Keep the lamp out of reach of unauthorised persons, especially children.
- Do not point the light directly in your own or any other person's or animal's eyes.
- Always check the mains cable before you use the charger. If the mains cable is damaged, replace the charger.
- Do not dispose of used batteries with domestic waste, but leave them at an appropriate collection point for disposal.
- The plastic in this product may contain chemicals known by the state of California to cause cancer and birth defects or other reproductive harm. Wash hands after handling.

Lamp design and accessories

- 600 lumen front main white SMD LED
Secondary rear 300 lumen white SMD LED
Extra top torch – 120 lumen white SMD LED
- Ultra tough nylon, aluminium construction
- 200° vertical folding head with super strong magnetic Base
- Buckle & Hanging system easy for use
- Two strong magnetic at the back side of lamp
- IK07 super tough shock resistant construction
- Large reflector SMD LED
- 5V charging system for recharging the batteries
- Built-in USB-C charging port with protective cover
- 1A direct USB-C charging - 3 hours charge time
- 1m USB-C charging cable included
- Safety design :
Charging and discharging protection
High efficiency & Low power consumption

Technical data

- 3.7V – rechargeable battery, Lithium 800mAh
- LED : Front Main 5W SMD LED
Rear 2.5W SMD LED
Top Torch : 1W SMD LED
- Luminance: Approx 600Lm Front Main
Approx 300Lm Rear LED
Approx 120Lm Top Torch
- Ambient temperature: -10° - +45°C
- Usage period: 3h to 6h for Main Front LED
6h for rear LED
6h for Top Torch LED
- Dimming switch for Main front LED : 100%-50%
- Charging period: approx. 3h
- Protection class: III
- Charging input: 5V 1000mA

Recharging

- Completely charge the batteries before your first use the lamp.
- The lamp must be charged per three months to protect the battery lifetime.

Charging using an 5V DC USB charger

- Plug the power supply into USB main charger
- Plug the charger cable into the USB-C socket .
- The red LED will light up during the charge. Once the batteries are completely charged, the LED turns green

Usage

The on-off switch

- Press 1st : Top Torch ON
- Press 2nd : Front Main 50% ON
- Press 3rd : Front Main 100% ON
- Press 4th : Rear LED 100% ON
- Press 5th : Front + Rear LED ON
- Press 6th : OFF

Noted :

If left in any mode for over 5 seconds , the next press will turn the light OFF .

How to use the lamp ?

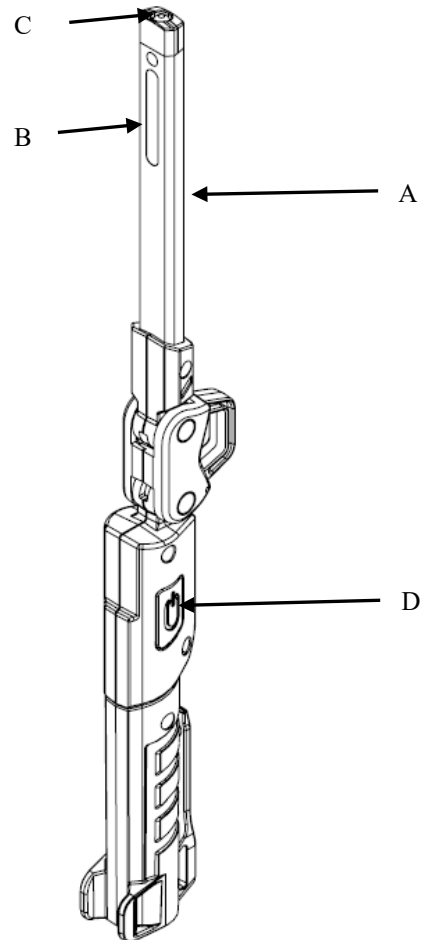
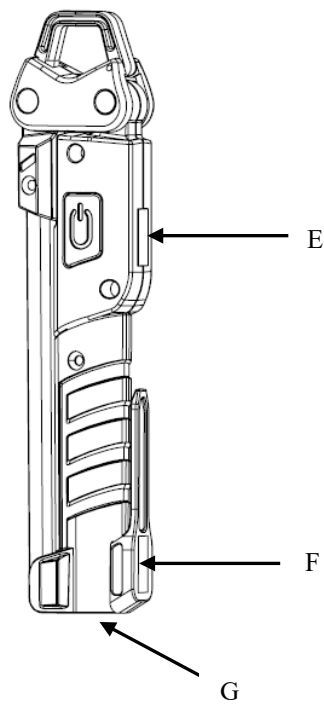
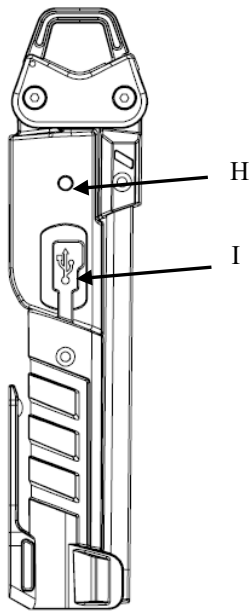

- A. Front Main SMD LED
- B. Rear SMD LED
- C. Top Torch SMD LED
- D. Switch
- E. Strong Magnet
- F. Strong Magnet
- G. Strong Magnet
- H. Battery Power Indicator
- I. USB-C Charging socket

Press to lock

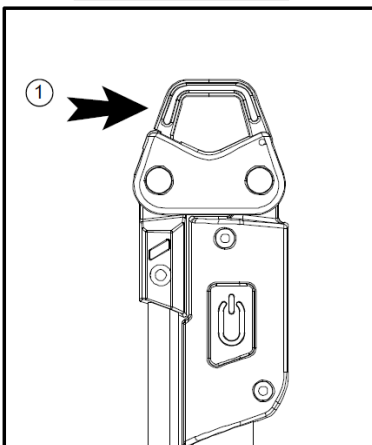

Push to unlock

